



## Sink Bernini 36" x 21" – U/M - (USA)

Kitchen Sinks

Code: 3780 660

AISI 304 Stainless steel

Satin finish

Undermount

x cross bending for easy water draining

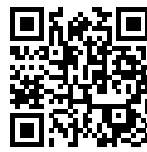

### DETAILS

Edge/Installation Type	Undermount
<b>Series</b>	Bernini
Finish	Satin finish
Material	AISI 304 stainless steel
Thickness	16 Gauge (1.5 mm)
Overall dimensions	37 <sup>31</sup> / <sub>64</sub> " x 22 <sup>31</sup> / <sub>64</sub> "
Bowls dimensions	1 bowl 36" x 15 <sup>3</sup> / <sub>4</sub> "
Bowls depth	10"

Cut out 36" x 21"

---

Waste fitting type 3 1/2" - with stainless steel basket

---

Bowls bottom X cross bending for easy water draining

---

Fixing system Undermount fixing kit (brass insert and clips)

---

Underside Protected with heavy duty undercoating

---

## FEATURES

**Diamond-shape bottom** The draining of water is an important feature in a sink, and it's always taken good care of in Foster products. In the bent-welded sinks, which would have a flat bottom, the proper draining is guaranteed by the elegant beveling, which helps the water flow.

---

**High thickness** 1.5 mm thick steel. A significant thickness, which guarantees the maximum sturdiness and durability.

---

**Basket 3,5" waste fitting** The drain is equipped with a large 3.5" drain, with the practical basket cap that prevents the discharge of solid parts.

---

## TECHNICAL DATA

3780 660

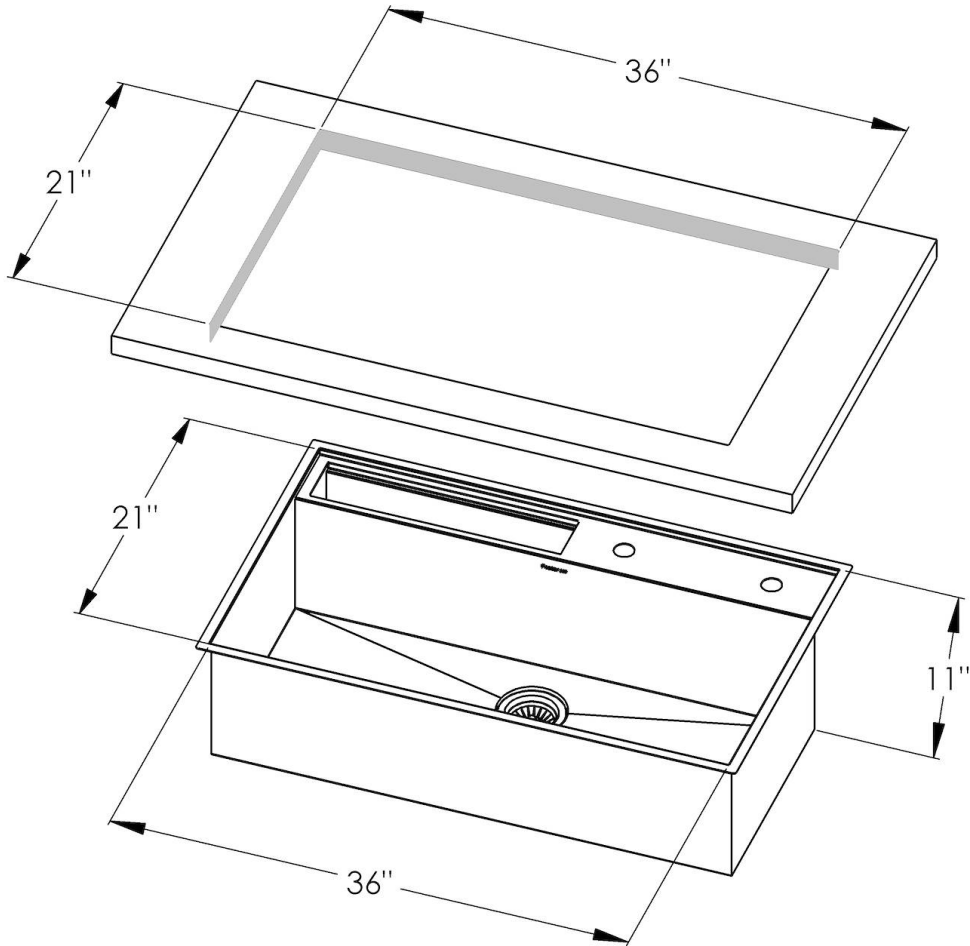

## Edge positioning

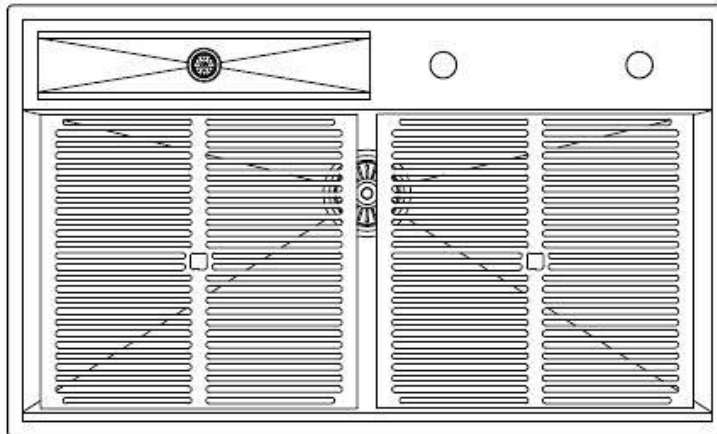
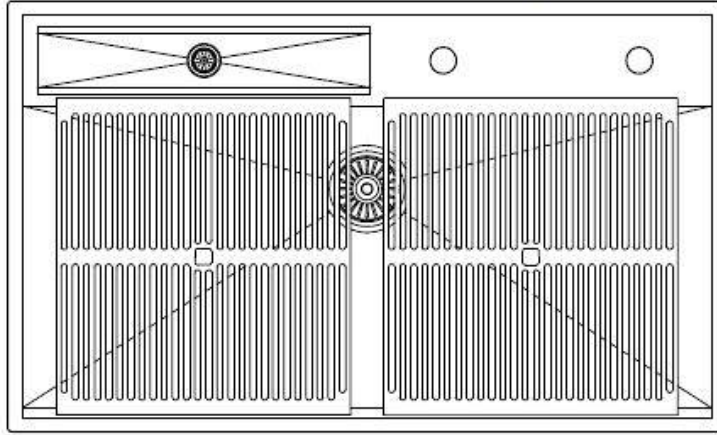

## Bottom positioning

## Bernini Optional accessories

The "rails" system makes it possible to use a combination of numerous accessories. Grids, chopping boards, utensils' ranging system, bowls and containers of different dimensions can be alternated in the workspace with a simple gesture, and can easily be stacked, in order to be on hand at all times.

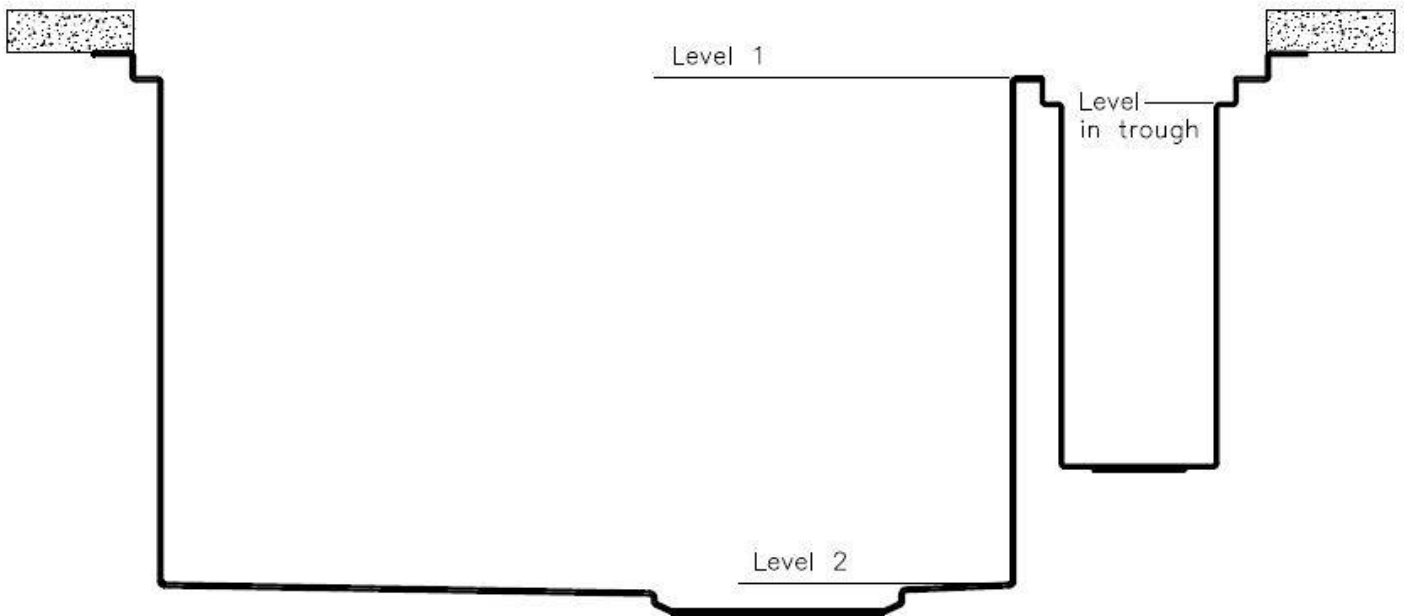

## Bernini Level 1

Compatible accessories:

8100 617

8200 002

8644 044

8100 201

8153 100

8657 001

8657 002

8631 300

8644 101

8151 000 (only to be matched with 8644 101)

8159 101 (only to be matched with 8644 101)

8100 303 (only to be matched with 8644 101)

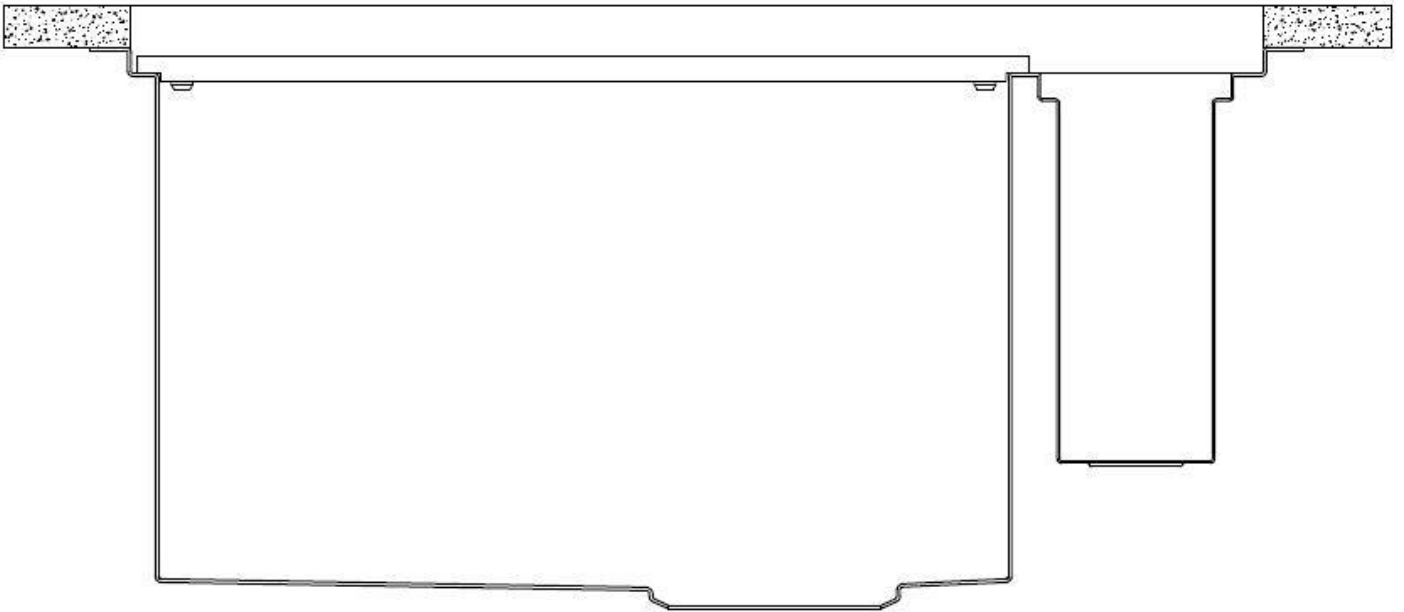

## **Bernini Level 2**

Compatible accessories:

8100 617

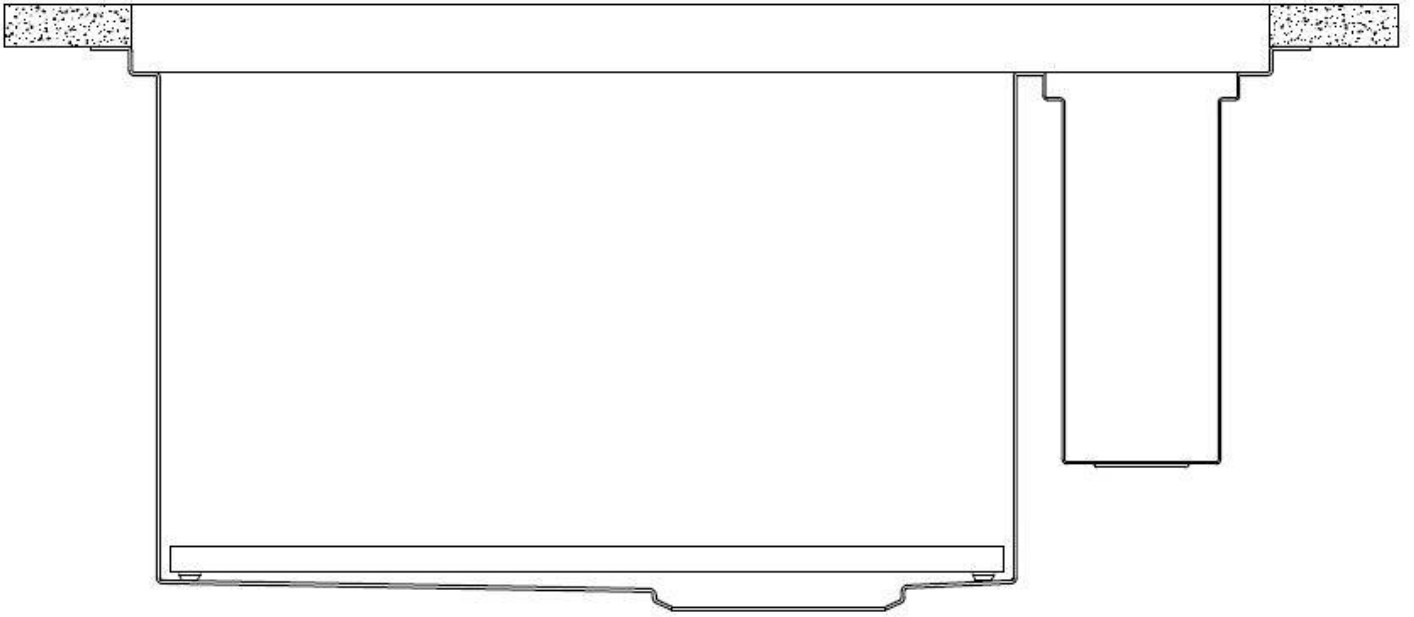

## **Bernini Level "in trough"**

Compatible accessories:

8100 709  
Kit con vaschetta

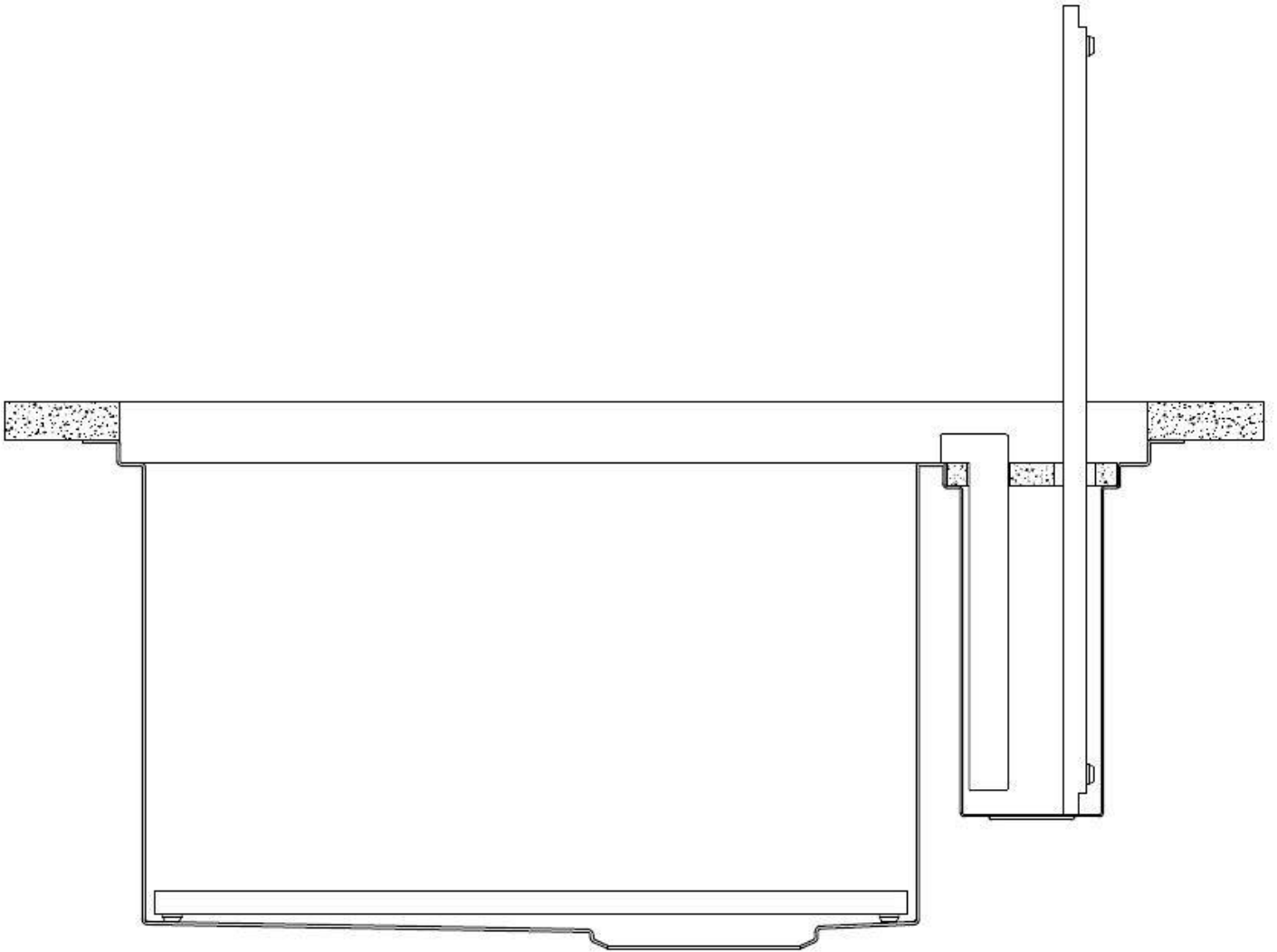



## GALLERY

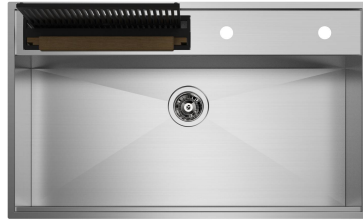
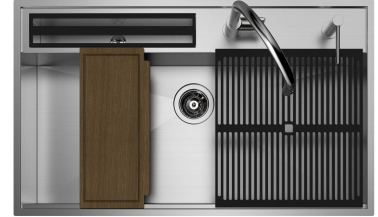

## EQUIPMENT



**Black grid**  
8100 617

## OPTIONAL ACCESSORIES



**Steel colander (cutlery holder +  
Black support)**  
8100 006



**Bamboo chopping board**  
8200 002



**Black grid**  
8100 617



**Grating kit complete with ring support and food collection tray**

8159 101

\* only in combination with the accessory  
8644 101



**HPDE Chopping board**

8657 001



**HPDE Chopping board GREY**

8657 002



**Iroko-wood sliding chopping board with stainless steel colander**

8644 044

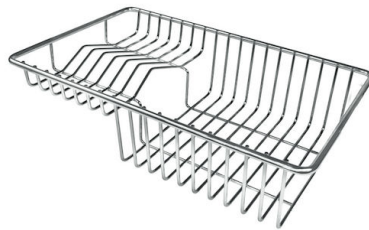

**Stainless Steel dishes holder**

8100 303

\* only in combination with the accessory  
8644 101



**Stainless steel perforated pan**

8151 000

\* only in combination with the accessory  
8644 101



**Stainless steel plate rack**

8100 201



**Waste disposer throat**

8669 043



**White bowl**

8153 100



**Twin Chopping Board**

8644 101



**Chopping Board**

8631 300

## RECOMMENDED PAIRINGS



**Dispenser Evo polished**  
8520 010



**Faucet Stromboli**  
8471 005



**Faucet Capri**  
8467 005



**Faucet Salina**  
8487 005



**Milano Cooktop 5 burners**  
7638 900